



54XDYYY-ZZZZ

1-1/2" Schedule 40 PVC Bath Waste/Overflow - Standard

Project Name: _____

Project Number: _____

Fixture #

Specification:

Direct style 1-1/2" Schedule 40 PVC Solvent Weld Bath Waste/Overflow Standard shall feature a Spin-on TiePlate, Angle Adapter (use optional), SlideOn™ Faceplate and Closure Mechanism.

*Certification



*The "cSAus Meets UPC" mark means the product conforms to the requirements of the NPC, UPC, IPC and IRC.

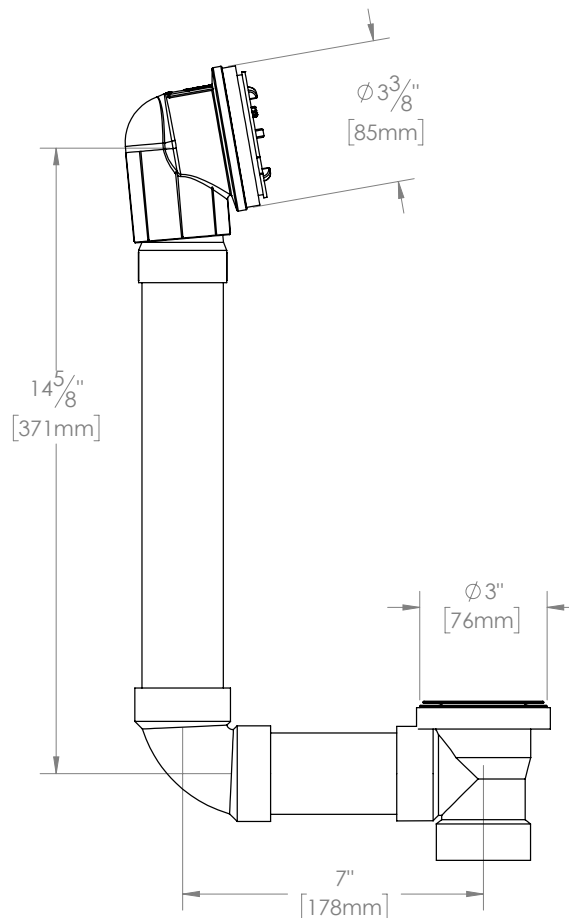

Refer to Side B for Faceplate, Closure Mechanism and Finish options and suffixes.

Oakville Stamping and Bending Ltd.

2200 Speers Road, Unit C. Oakville, ON. Canada. L6L 2X8.

T. 905.827.0320 or toll free 1.877.314.6040 F. 905.827.6375 or toll free 1.877.827.6040.

All rights reserved. OS&B™ reserves the right to change product specifications and material or discontinue models without notice.

www.osb.ca (Canada) www.osbplumbing.com (USA)

Faceplate
Suffix

Closure
Suffix

Finish
Suffix

SELECT FACEPLATE SUFFIX BELOW AND TRANSPOSE ABOVE (no SUFFIX req'd for BELL):

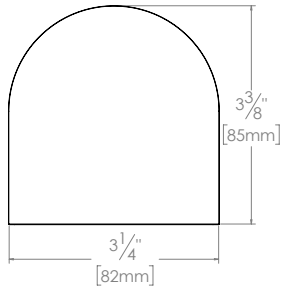

**NO SUFFIX
(BELL)**

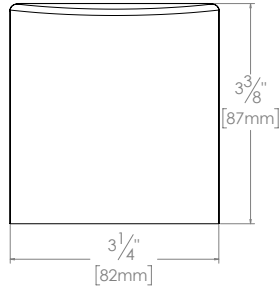

**1
(SQUARE)**

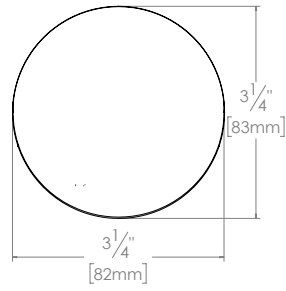

**2
(ROUND)**

SELECT CLOSURE SUFFIX BELOW AND TRANSPOSE ABOVE:

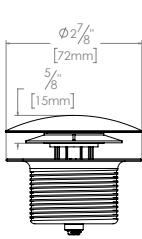

**Q
(Clicker)**

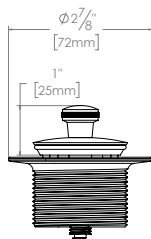

**L
(Lift & Turn)**

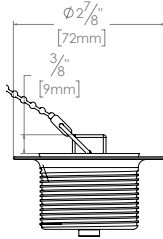

**CS
(Plug & Chain)**

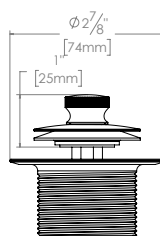

**PP
(Push-Pull*)**

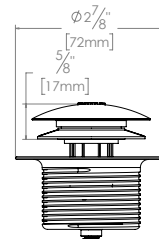

**TIP
(Tip Toe)**

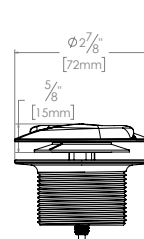

**T
(Twirl)**

SELECT FINISH SUFFIX BELOW AND TRANSPOSE ABOVE (CHECK AVAILABILITY BELOW):



**BCP
(Brass
Chrome
Plated)**



**BN
(Brushed
Nickel)**



**BG
(Brushed
Gold)**



**CP
(Chrome
Plated)**



**LB
(Luxe
Bronze)**



**MBL
(Matte
Black)**



**POLN
(Polished
Nickel)**



**PB
(Polished
Brass)**

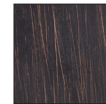

**VB
(Venetian
Bronze)**



**W
(White)**

FINISH AVAILABILITY BY CLOSURE:

	BCP	BN	BG	CP	LB	MBL	POLN	PB	VB	W
Q - Clicker®	✓	✓	✓	✓	✓	✓	✓	✓	✓	✓
L - Lift & Turn		✓		✓			✓	✓	✓	✓
CS - Plug & Chain				✓						
PP - Push-Pull*				✓						
TIP - Tip-Toe				✓						
T - Twirl™		✓		✓						

*Push-Pull n/a in USA